



EnerRocket™
CONTINUOUSLY SAFEGUARDING

ES 65-12

SMF VRLA RECHARGEABLE BATTERY

**LONG
LIFE
SERIES**

APPLICATIONS

- UPS Systems
- Telecommunication Systems
- Fire Alarm Safety & Security Systems
- Medical Equipment

COMPLIANCE STANDARDS

- IEC 60896 PART 21 & 22
- BS6290-4

TECHNICAL FEATURES



- Non-Spillable Sealed Construction
- Seal Lead Acid Battery
- Absorptive Glass Mat System (AGM System)
- ABS (Acrylonitrile Butadiene Styrene) construction (FR optional)
- Gas Recombination
- Venting System for low internal pressure
- Low Self-Discharge
- Heavy-Duty, Highly Optimized Grids
- High Power Output
- Wide Operating Temperature
- Maintenance-Free Operation

CHARACTERISTICS

Nominal Voltage	12 V	
Design Life	10 Years	
Capacity 25°C (77°C)	20 Hour rate	68Ah
	10 Hour rate	65Ah
	5 Hour rate	55Ah
Internal Resistance (25°C, 100% Charge)	≤ 6.8 mΩ	
Self Discharge (20°C)	1 Month	Remaining Capacity 97%
Operating Temperature	Discharge	-20°C - 60°C
	Charge	-10°C - 60°C
	Storage	-20°C - 60°C
Normal Operating Temperature	25°C ± 3°C	
Maximum Discharge current	650A (5sec)	
Maximum Charging current	26A	
Short Circuit Current	1700A	
Charge Methods Constant Voltage Charge 77°F (25°C) - Cycle use	14.4 to 14.7V	
	Temp. Compensation -30mV/°C	
Charge methods Constant Voltage Charge 77°F (25°C) - Standby Use	13.4 to 13.8V	
	Temp. Compensation -20mV/°C	

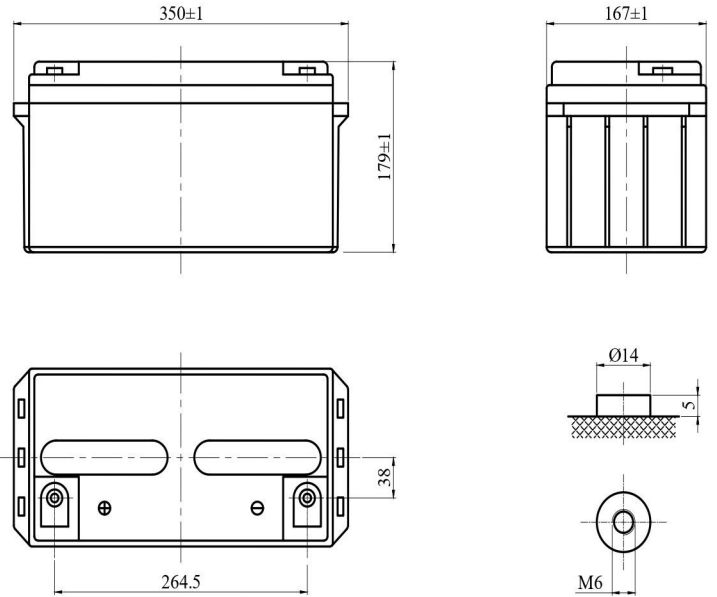

SPECIFICATIONS

Length	Width	Height	Total Height	Weight (kg)
350 mm	167 mm	179mm	179 mm	20.4 ± 5%

CONSTANT CURRENT DISCHARGE (Amperes) AT 25°C

End Voltage Volts/Cell	5min	10min	15min	30min	1h	3h	5h	10h	20h
1.60	212	151	126	75.4	45.10	18.4	11.8	6.7	3.48
1.65	201	144	121	73.3	44.00	18	11.6	6.58	3.46
1.70	189	137	115	71.3	43.00	17.6	11.3	6.56	3.44
1.75	177	129	109	69.2	41.90	17.2	11.0	6.53	3.42
1.80	164	120	102	66.9	41.00	16.9	10.7	6.50	3.40

CONSTANT POWER DISCHARGE (Watts) AT 25°C

End Voltage Volts/Cell	5min	10min	15min	30min	1h	3h	5h	10h	20h
1.60	378	275	207	129	81.80	33.8	22.5	11.7	6.40
1.65	356	261	203	128	80.00	33.2	22.3	11.6	6.30
1.70	335	246	200	127	78.30	32.5	22.0	11.5	6.20
1.75	314	231	196	124	76.50	31.8	21.7	11.4	6.20
1.80	302	215	187	122	75.70	31.1	21.4	11.3	6.00



ES 65-12

SMF VRLA RECHARGEABLE BATTERY

**LONG
LIFE
SERIES**

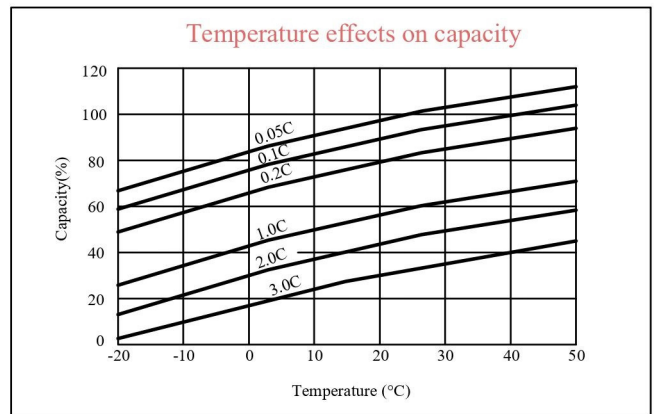
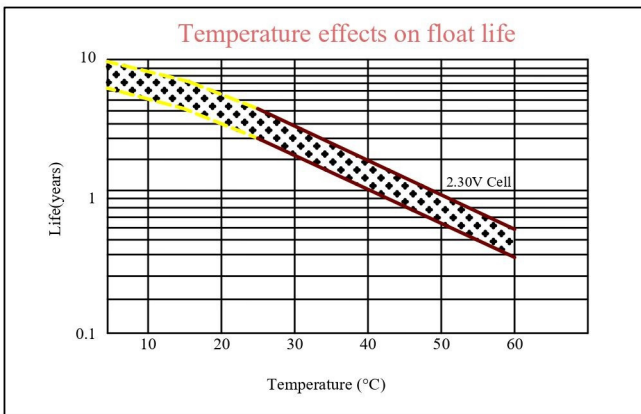
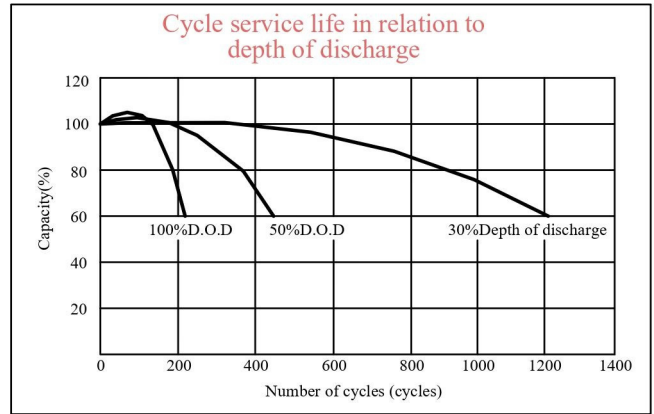
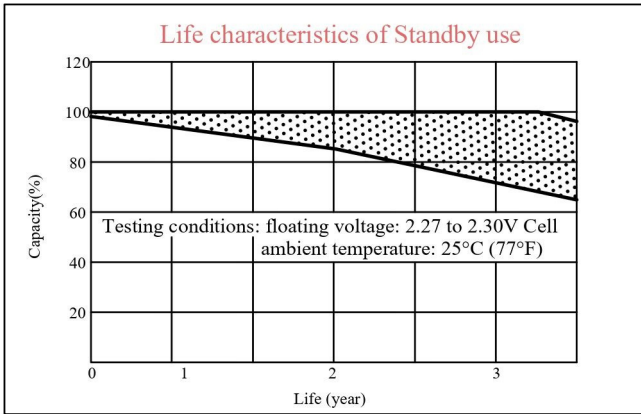
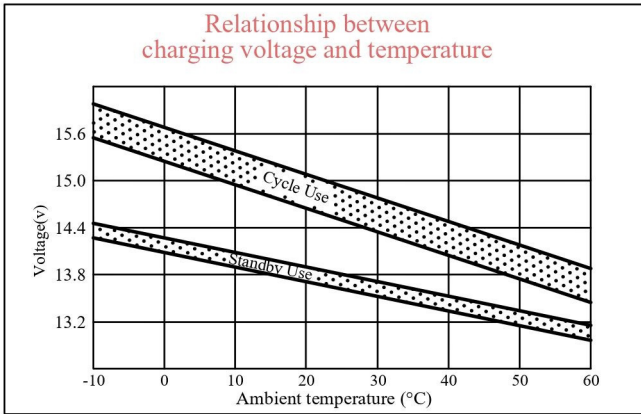
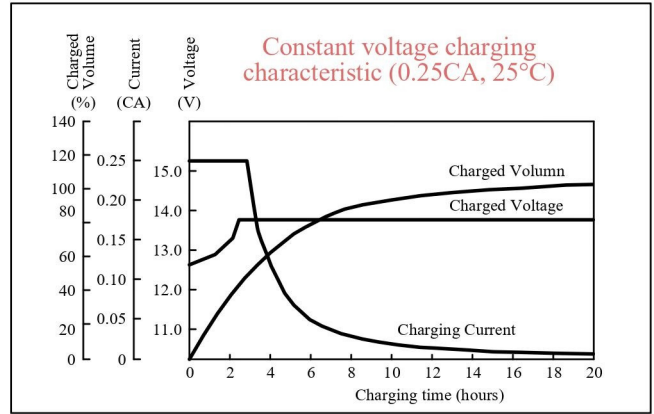
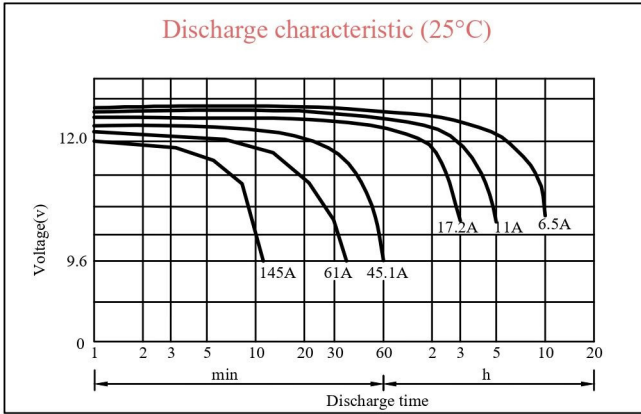

v205.2