



EnerRocket™
CONTINUOUSLY SAFEGUARDING

ESC 150-12 FR

SMF VRLA RECHARGEABLE BATTERY

**LONG
LIFE
SERIES**

APPLICATIONS

- UPS Systems
- Telecommunication Systems
- Fire Alarm Safety & Security Systems
- Medical Equipment

COMPLIANCE STANDARDS

- IEC 60896 PART 21 & 22
- BS6290-4
- EUROBAT- HIGH Performance

TECHNICAL FEATURES



- Non-Spillable Sealed Construction
- Absorbent Glass Mat System (AGM System)
- ABS (Acrylonitrile Butadiene Styrene) construction
- Gas Recombination
- Venting System for low internal pressure
- Low Self-Discharge
- Heavy-Duty, Highly Optimized Grids
- High Power Output

CHARACTERISTICS

Nominal Voltage	12 V	
Design Life	12 Years	
Capacity (25°C)	10 Hour rate	153Ah
Internal Resistance (25°C, 100% Charge)	≤4.0 mΩ	
Self Discharge (20°C)	1 Month	Remaining Capacity 97%
Operating Temperature	Discharge	-20°C - 60°C
	Charge	-10°C - 60°C
	Storage	-20°C - 60°C
Normal Operating Temperature	25°C ± 3°C	
Maximum Discharge current (25°C)	1000A (5sec)	
Maximum Charging current (25°C)	45A	
Short Circuit Current	2800A	
Charge Methods	14.4 to 14.7 V	
Constant Voltage Charge 77°F (25°C) - Cycle use	Temp. Compensation -30mV/°C	
Charge methods	13.4 to 13.8V	
Constant Voltage Charge 77°F (25°C) - Standby Use	Temp. Compensation -20mV/°C	

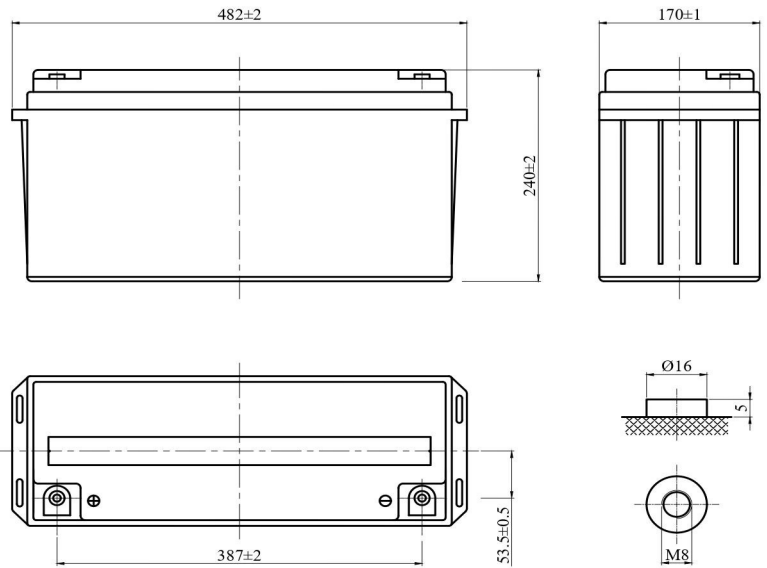

SPECIFICATIONS

Length	Width	Height	Total Height	Weight (kg)
482mm	170mm	240mm	240mm	42.5 ± 5%

CONSTANT CURRENT DISCHARGE (Amperes) AT 25°C

End Voltage Volts/Cell	15min	20min	30min	1h	1.5h	2h	3h	4h
1.60	300	186	173	98.6	72.0	57.8	44.7	33.00
1.65	281	177	163	95.2	69.8	55.4	43.4	32.01
1.70	264	167	155	92.1	67.7	53.2	41.6	31.05
1.75	247	158	149	89.3	65.7	51.6	40.5	30.12
1.80	226	153	143	84.5	63.7	50.1	39.8	29.21

CONSTANT POWER DISCHARGE (Watts) AT 25°C

End Voltage Volts/Cell	15min	20min	30min	1h	1.5h	2h	3h	4h
1.60	524.9	434	314.5	185.3	136	118	85.4	61.4
1.65	499.1	419	300.0	179.9	133	114	83.3	59.5
1.70	473.0	404	286.7	175.3	130	110	80.2	57.8
1.75	449.3	388	277.0	170.5	126	94	78.2	56.3
1.80	416.4	374	269.0	163.7	122	88	77.1	54.9



EnerRocket™
CONTINUOUSLY SAFEGUARDING



ESC 150-12 FR

SMF VRLA RECHARGEABLE BATTERY

**LONG
LIFE
SERIES**

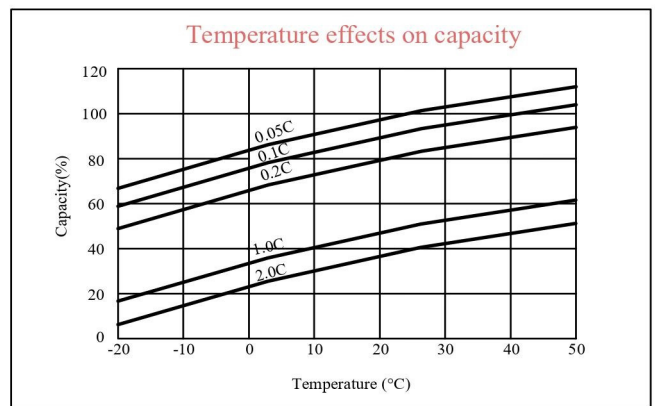
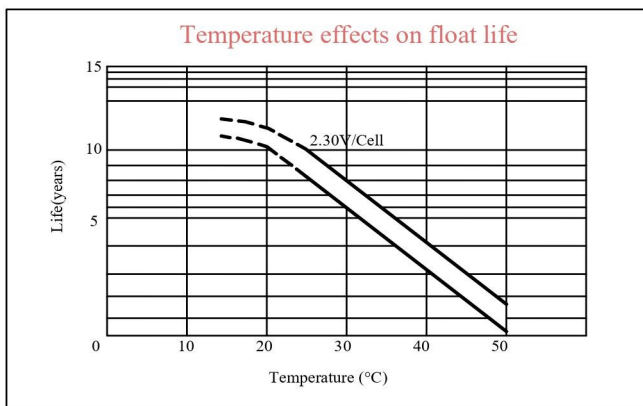
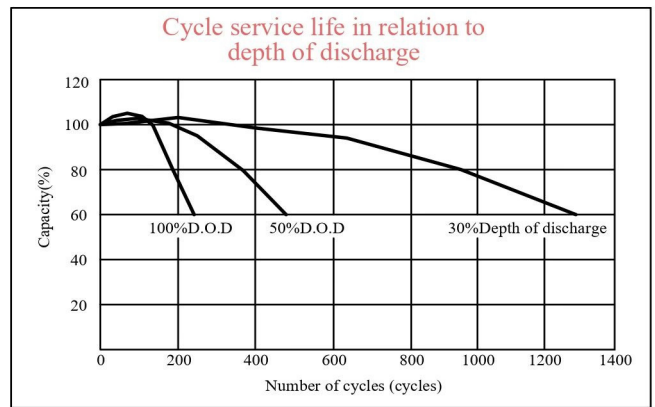
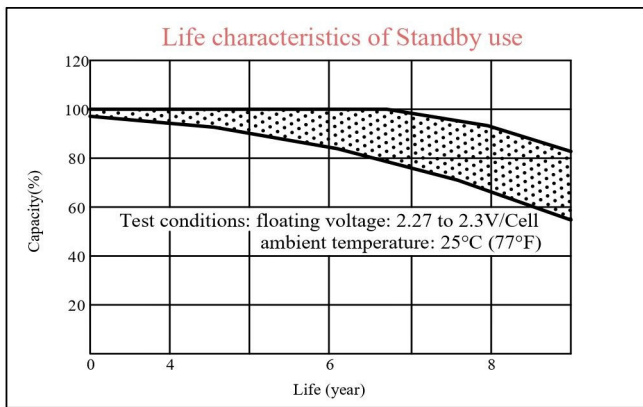
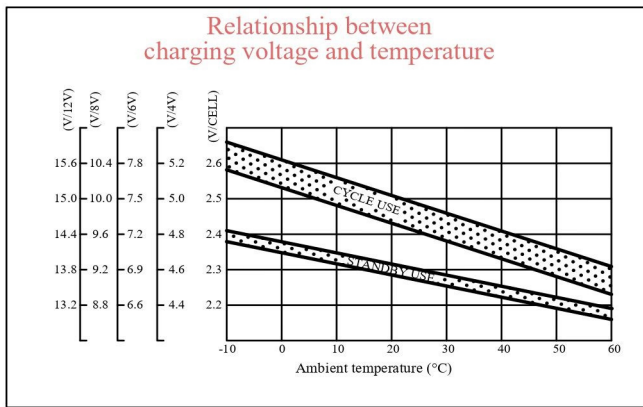
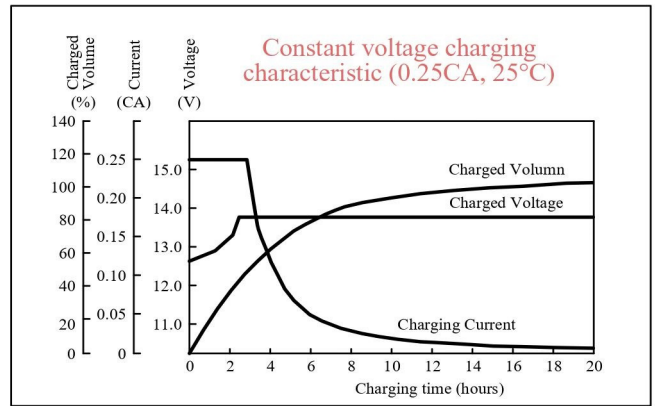
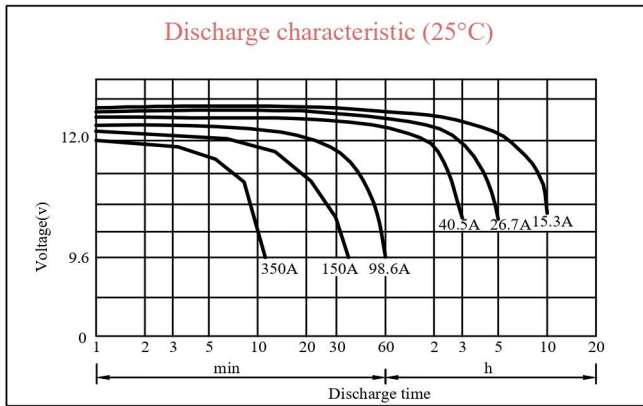

Note:
GPSGC reserves the right to make changes to the above values without any notice.
All data and discharge characteristics are average values based on actual discharge cycle tests performed and not minimum values.

v205.2