



EnerRocket™
CONTINUOUSLY SAFEGUARDING

ESC 100-12 FR

SMF VRLA RECHARGEABLE BATTERY

**LONG
LIFE
SERIES**

APPLICATIONS

- UPS Systems
- Telecommunication Systems
- Fire Alarm Safety & Security Systems
- Medical Equipment

COMPLIANCE STANDARDS

- IEC 60896 PART 21 & 22
- BS6290-4
- EUROBAT- HIGH Performance

TECHNICAL FEATURES



- Non-Spillable Sealed Construction
- Absorbent Glass Mat System (AGM System)
- ABS (Acrylonitrile Butadiene Styrene) construction
- Gas Recombination
- Venting System for low internal pressure
- Low Self-Discharge
- Heavy-Duty, Highly Optimized Grids
- High Power Output

CHARACTERISTICS

Nominal Voltage	12 V	
Design Life	12 Years	
Capacity (25°C)	10 Hour rate	100Ah
Internal Resistance (25°C, 100% Charge)	≤5.7 mΩ	
Self Discharge (20°C)	1 Month	Remaining Capacity 97%
Operating Temperature	Discharge	-20°C - 60°C
	Charge	-10°C - 60°C
	Storage	-20°C - 60°C
Normal Operating Temperature	25°C ± 3°C	
Maximum Discharge current (25°C)	500A (5sec)	
Maximum Charging current (25°C)	30A	
Short Circuit Current	2100A	
Charge Methods	14.4 to 14.7 V	
Constant Voltage Charge 77°F (25°C) - Cycle use	Temp. Compensation -30mV/°C	
Charge methods	13.4 to 13.8V	
Constant Voltage Charge 77°F (25°C) - Standby Use	Temp. Compensation -20mV/°C	

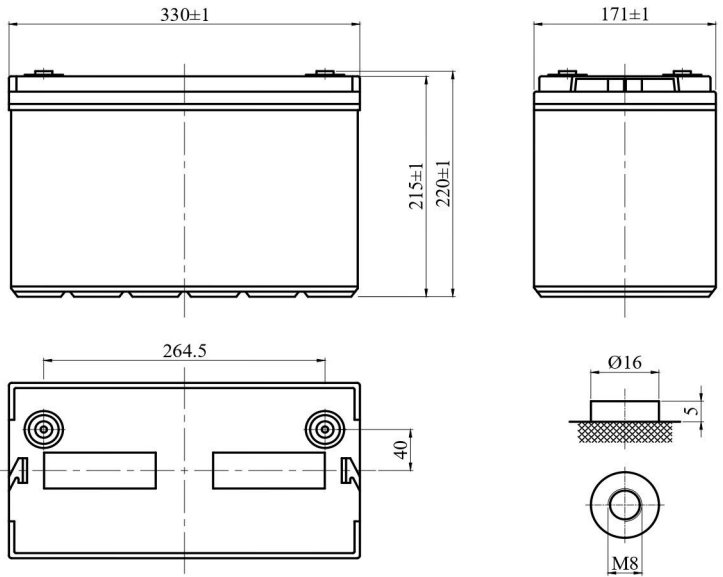

SPECIFICATIONS

Length	Width	Height	Total Height	Weight (kg)
330mm	171mm	215mm	220mm	28.0 ± 3%

CONSTANT CURRENT DISCHARGE (Amperes) AT 25°C

End Voltage Volts/Cell	15min	20min	30min	1h	1.5h	2h	3h	4h
1.60	173	110	98.9	61.0	45.3	35.0	25.1	22.4
1.65	164	101	95.0	60.6	44.0	33.6	24.6	21.8
1.70	156	97	92.2	59.7	42.7	32.3	24.1	21.5
1.75	145	93	89.3	58.9	41.4	31.3	23.5	21.0
1.80	136	89	87.4	57.1	40.1	30.7	22.8	20.2

CONSTANT POWER DISCHARGE (Watts) AT 25°C

End Voltage Volts/Cell	15min	20min	30min	1h	1.5h	2h	3h	4h
1.60	304	202	198	119	84.3	68.2	48.4	41.9
1.65	299	195	187	117	82.7	67.0	47.8	40.8
1.70	290	190	182	116	80.2	65.8	47.3	40.0
1.75	279	183	176	112	78.2	64.6	46.7	38.1
1.80	270	178	170	109	76.3	63.9	45.9	37.4



ESC 100-12 FR

SMF VRLA RECHARGEABLE BATTERY

**LONG
LIFE
SERIES**

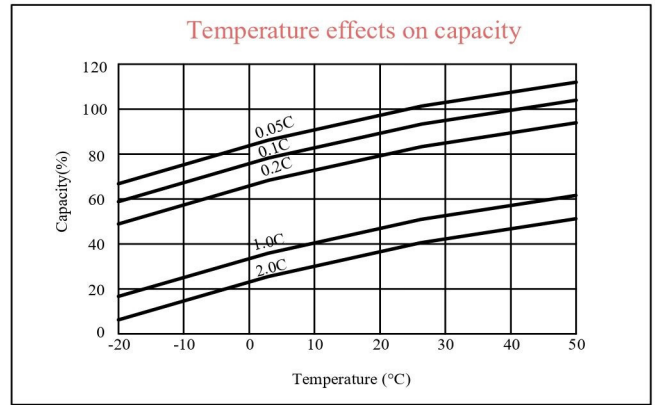
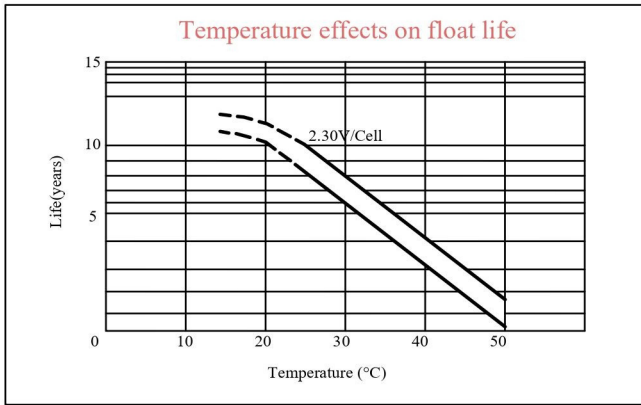
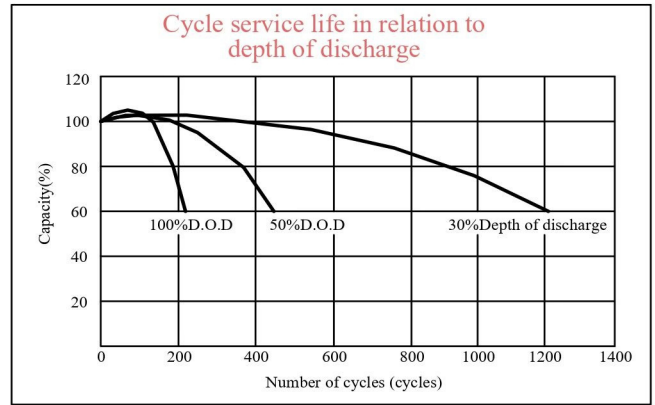
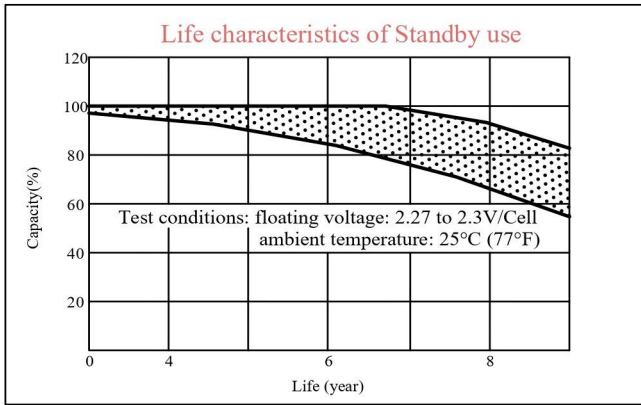
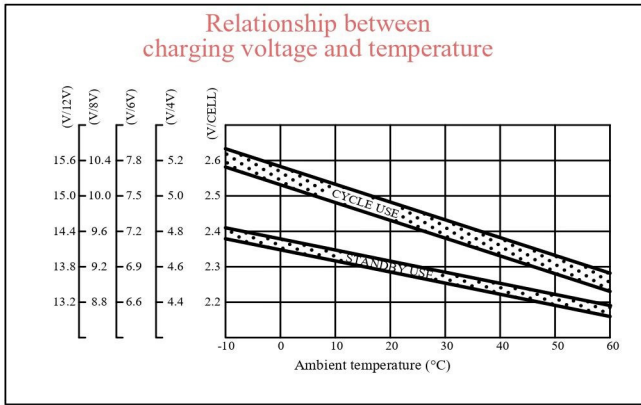
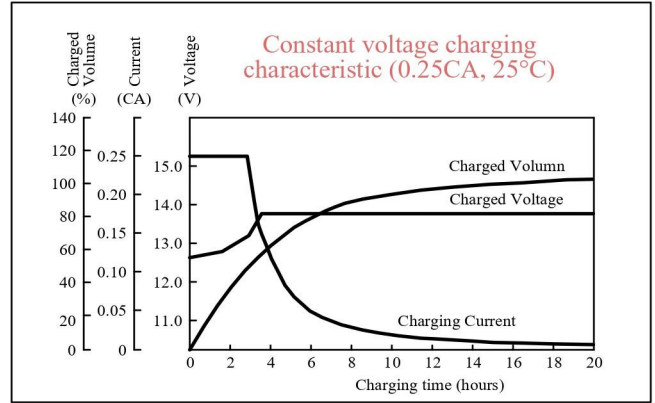
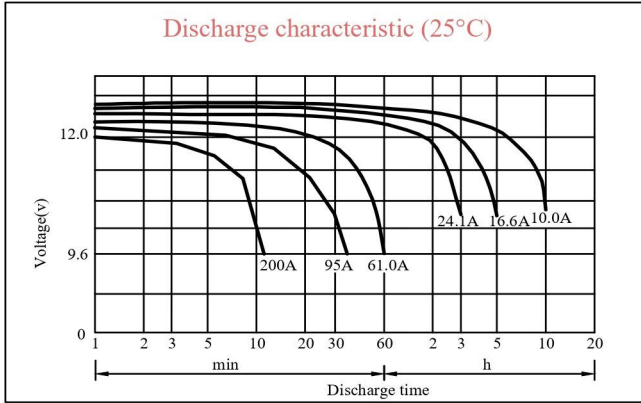

Note:
GPSGC reserves the right to make changes to the above values without any notice.
All data and discharge characteristics are average values based on actual discharge cycle tests performed and not minimum values.

v205.1