



EnerRocket™
CONTINUOUSLY SAFEGUARDING

ES 26-12

SMF VRLA RECHARGEABLE BATTERY

**LONG
LIFE
SERIES**

APPLICATIONS

- UPS Systems
- Telecommunication Systems
- Fire Alarm Safety & Security Systems
- Medical Equipment

COMPLIANCE STANDARDS

IEC 60896 PART 21 & 22
BS6290-4

TECHNICAL FEATURES



- Non-Spillable Sealed Construction
- Seal Lead Acid Battery
- Absorbent Glass Mat System (AGM System)
- ABS (Acrylonitrile Butadiene Styrene) construction (FR optional)
- Gas Recombination
- Venting System for low internal pressure
- Low Self-Discharge
- Heavy-Duty, Highly Optimized Grids
- High Power Output
- Wide Operating Temperature
- Maintenance-Free Operation

CHARACTERISTICS

| | | |
|---|-----------------------------|------------------------|
| Nominal Voltage | 12 V | |
| Design Life | 10 Years | |
| Capacity 25°C (77°F) | 20 Hour rate | 26Ah |
| | 10 Hour rate | 23.7Ah |
| | 5 Hour rate | 20.5Ah |
| Internal Resistance (25°C, 100% Charge) | ≤ 12 mΩ | |
| Self Discharge (20°C) | 1 Month | Remaining Capacity 97% |
| Operating Temperature | Discharge | -20°C - 60°C |
| | Charge | -10°C - 60°C |
| | Storage | -20°C - 60°C |
| Normal Operating Temperature | 25°C ± 3°C | |
| Maximum Discharge current | 300A (5sec) | |
| Maximum Charging current | 9.6A | |
| Short Circuit Current | 1200A | |
| Charge Methods | 14.4 to 14.7V | |
| Constant Voltage Charge 77°F (25°C) - Cycle use | Temp. Compensation -30mV/°C | |
| Charge methods | 13.4 to 13.8V | |
| Constant Voltage Charge 77°F (25°C) - Standby Use | Temp. Compensation -20mV/°C | |

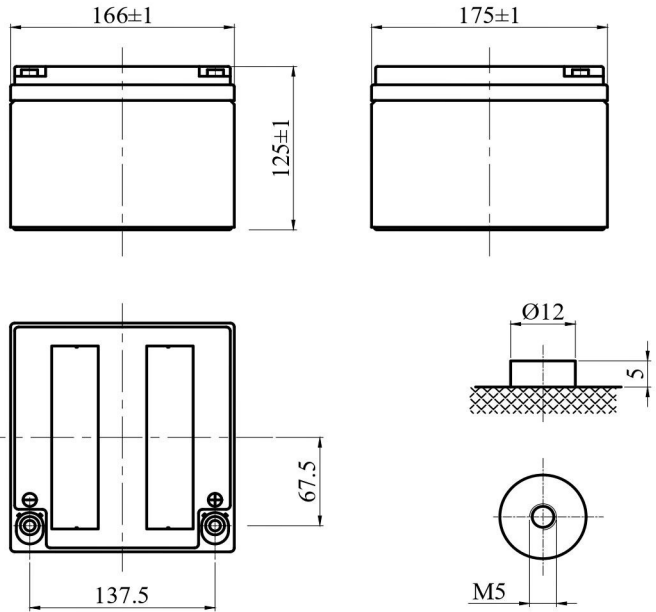

SPECIFICATIONS

| Length | Width | Height | Total Height | Weight (kg) |
|--------|--------|--------|--------------|-------------|
| 166 mm | 175 mm | 125mm | 125 mm | 8.1 ± 5% |

CONSTANT CURRENT DISCHARGE (Amperes) AT 25°C

| End Voltage Volts/Cell | 5min | 10min | 15min | 30min | 1h | 3h | 5h | 10h | 20h |
|------------------------|------|-------|-------|-------|------|------|------|------|------|
| 1.60 | 95.0 | 64.0 | 48.0 | 28.5 | 16.0 | 6.74 | 4.47 | 2.52 | 1.32 |
| 1.65 | 90.1 | 60.9 | 45.9 | 27.4 | 15.4 | 6.53 | 4.36 | 2.47 | 1.31 |
| 1.70 | 84.9 | 57.8 | 43.7 | 26.2 | 14.8 | 6.30 | 4.24 | 2.42 | 1.31 |
| 1.75 | 79.7 | 54.5 | 41.1 | 24.9 | 14.2 | 6.05 | 4.10 | 2.37 | 1.30 |
| 1.80 | 74.3 | 51.3 | 39.1 | 23.6 | 13.5 | 5.78 | 3.95 | 2.31 | 1.28 |

CONSTANT POWER DISCHARGE (Watts) AT 25°C

| End Voltage Volts/Cell | 5min | 10min | 15min | 30min | 1h | 3h | 5h | 10h | 20h |
|------------------------|------|-------|-------|-------|------|------|------|------|------|
| 1.60 | 185 | 121 | 90.0 | 55.0 | 31.7 | 13.4 | 8.54 | 5.38 | 2.78 |
| 1.65 | 173 | 114 | 85.1 | 52.3 | 30.3 | 13.1 | 8.39 | 5.35 | 2.77 |
| 1.70 | 161 | 107 | 80.2 | 49.4 | 28.9 | 12.5 | 8.22 | 5.30 | 2.73 |
| 1.75 | 151 | 99.7 | 75.2 | 46.6 | 27.5 | 12.0 | 8.03 | 5.18 | 2.68 |
| 1.80 | 139 | 92.7 | 70.3 | 43.7 | 26.0 | 11.4 | 7.83 | 5.12 | 2.62 |



ES 26-12

SMF VRLA RECHARGEABLE BATTERY

**LONG
LIFE
SERIES**

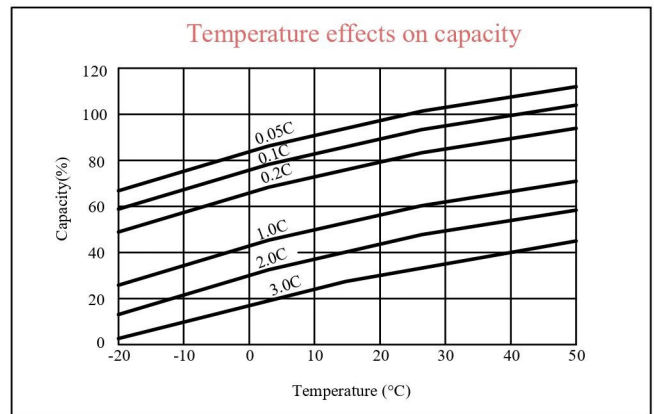
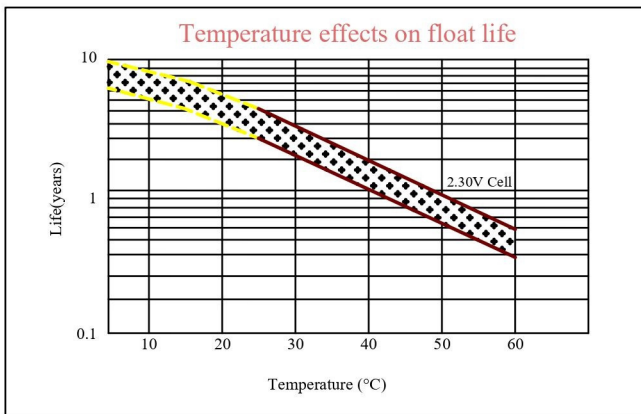
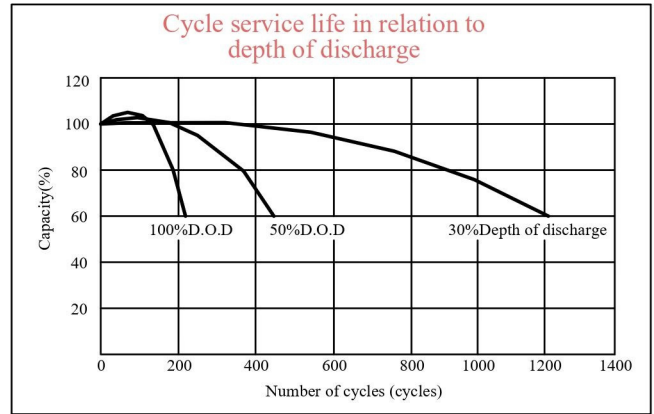
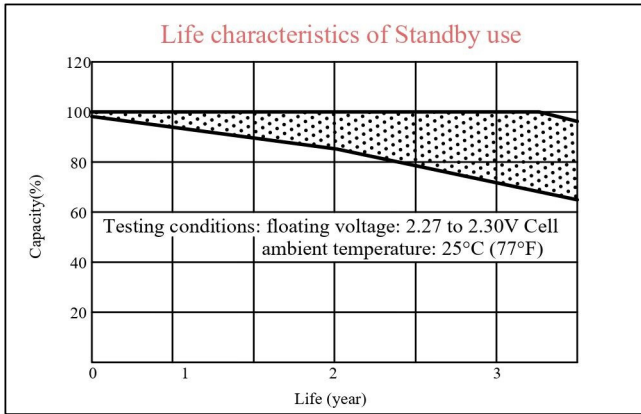
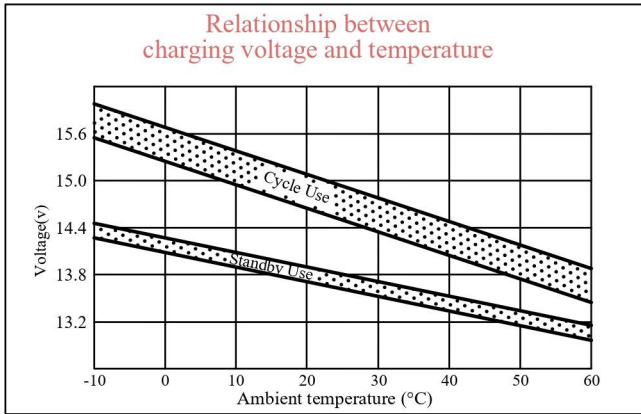
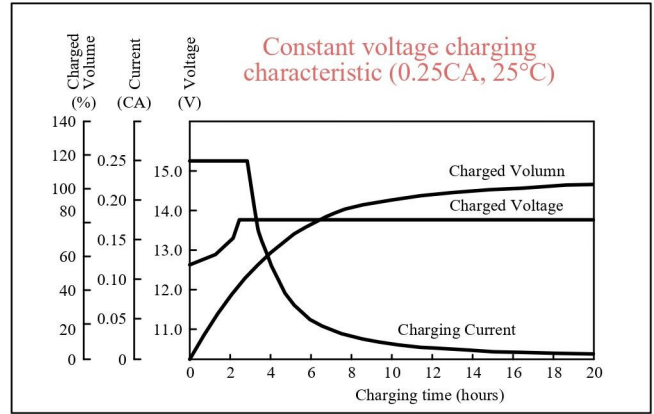
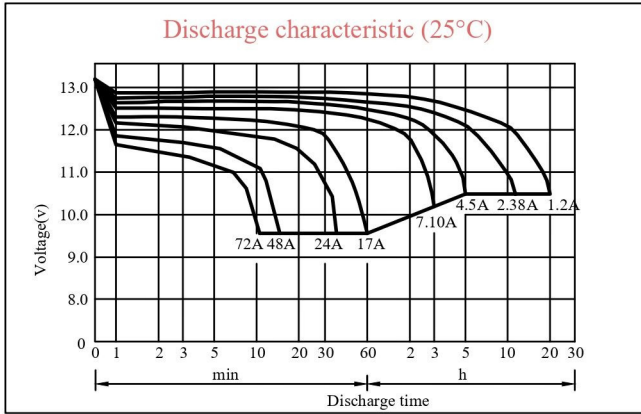

v205.2